



SUPERSTAR

SARL au capital de 762 500 €

Route de Pagny

**21250 SEURRE - France**

TEL. 03 80 26 91 91 - FAX 03 80 26 91 00

E-mail : [superstar@crtfrance.com](mailto:superstar@crtfrance.com)

Web site : [www.crtfrance.com](http://www.crtfrance.com)



**CRT SS 7900**



## **USER MANUAL**

# **10 Meter Amateur Radio**

**Copyright CRT France 2015**

CE 0700



# SYMBOLS DESCRIPTION

---

Please carefully read the instructions



**Information on recycling**, not throwing your material in the trash at the end of life, bring it to special area to be recycling



DC using



Keep dry



Shield symbol



CE conformity symbol



Alert symbol indicating an incomplete harmonization of the frequency band which will result in restrictions on the use of the equipment concerned.



Warning



---

## STORAGE , TRANSPORT, USING

**Storage : Classe 1 -30/85% (°humidity)**

**Transport :- 30/85% (°humidity)**

**Operating temperature -30 à + 50°**

**Using cycle TX 10%/RX 90%**



## Warned before use

This transceiver corresponds to the requirements of European directives R&TTE and answers the European standards of telecommunication EN 60950-1, EN 301 489-1/-15, EN 301 783-1/-2 and EN 62311.

**IMPORTANT** : This receiving transmitter works on not free frequencies in the use. The user has to possess a radio license amateur radio (certificate of radio operator HAM) to use it (in emission) and only on the frequencies authorized in radio amateurs.



## Precautions



Please observe the following precautions to prevent fire, personal injury, or transceiver damage.



Do not attempt to configure your transceiver while driving, it is dangerous.



This transceiver is designed for a 13.8V DC power supply. Don't use a 24V battery to power on the transceiver.



Do not place the transceiver in excessively dusty, humid or wet areas, nor unstable surfaces.



Do not connect the antenna while transmission, risk of burn or electric shock.



Please keep it away from interferential devices (such as TV, generator etc.) devices (such as TV, generator etc.)



For those fitted with pacemakers are advised to move away from the antenna during transmission, mainly in high power, and especially do not touch it.



Never allow metal objects or son electrical contact with the part or internal electrical connection to the risk of electric shock.



Avoid exposing the transceiver to temperatures below  $-30^{\circ}\text{C}$ . and above  $+60^{\circ}\text{C}$ , the temperature of the dashboard inside a vehicle can sometimes exceed  $80^{\circ}\text{C}$ , which can damage irreparable damage to your machine in case of prolonged exposure. Not exposed to prolonged direct sunlight or place it near heaters.



Do not place anything on top of the apparatus that would interfere with cooling.



Check that your battery is sufficiently charged to avoid rapidly exhausting its resources.



It is important to turn off your device before starting the vehicle to avoid damage caused by spikes in the ignition.



When replacing the fuse, you must use a fuse 5A 250V type F  
In no case a higher value!, Otherwise a fire hazard.



If an abnormal odor or smoke is detected coming from the transceiver, turn OFF the power immediately.  
Contact an CRT service station or your dealer.



Do not transmit with high output power for extended periods; the transceiver may overheat.



Keep out from children.

**Attention :**

- Before using your transceiver please connect an antenna on the connector PL on back side then check the SWR before emitting. A too important SWR can entail the destruction of the transistors of power which are not flatware by the guarantee

# CONTENTS

<b>FUNCTIONS &amp; FEATURES</b> .....	<b>1</b>
<b>STANDARD ACCESSORIES</b> .....	<b>2</b>
<b>INSTALLATION</b> .....	<b>2</b>
<b>GETTING ACQUAINTED</b> .....	<b>5</b>
<b>HOW TO USE YOUR RADIO</b> .....	<b>7</b>
<b>KEYPAD FUNCTION</b> .....	<b>9</b>
<b>BACKGROUND FUNCTION MENU OPERATION</b> .....	<b>12</b>
<b>SPECIFICATIONS</b> .....	<b>13</b>

## FUNCTIONS & FEATURES

- ◆ Big LCD displays frequency and all kinds of information
- ◆ FM、AM、USB、LSB、PA mode
- ◆ Frequency Tuning Step 100Hz、1KHz、10KHz、100KHz、1MHz
- ◆  $\pm 1.5$ KHz CLARLFILER Adjustment
- ◆ Flexible Menu Function and PC Program Software
- ◆ ECHO Function
- ◆ SQ, ASQ Function (FM and AM mode only)
- ◆ RF GAIN Adjustment
- ◆ RF PWR Adjustment
- ◆ SCAN Function
- ◆ Programmable RB Function
- ◆ NB/ANL Function
- ◆ DW DUAL-WATCH Function
- ◆ Offset Frequency Function
- ◆ BEEP Voice Prompt
- ◆ +10KHZ Function
- ◆ SIG、PWR、SWR Function
- ◆ TOT function
- ◆ HI-CUT Function
- ◆ EMG Channel Function
- ◆ SWR Protection
- ◆ Power Supply Voltage Protection
- ◆ Key-Lock Function
- ◆ Six(6) Groups Memory Channel
- ◆ Model Name Customized Function
- ◆ CTCSS/DCS Code(included)

## ■ STANDARD ACCESSORIES

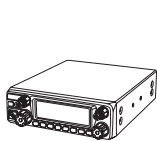

Radio



Microphone

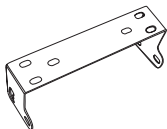

Mounting Bracket



Microphone Hanger



Non-slip Mat



Screws for bracket



Pads for bracket



Adjusting screws



Spare Fuses (10A,250V)



Self-tapping Screws



power cord

## ■ INSTALLATION

Choose the most appropriate setting from a simple and practical point of view. Your radio should not interfere with the driver or crash the driver's knee or leg when rush brake.

1. Using the self-tapping screws and pads(2 sets) to fix the bracket.
2. Put the Non-slip mat on the 2 ends of the bracket and put in the radio. Then insert the adjusting screws and check careful each screws, make sure the screws and machine will not loose when the car shaking.
3. Choose suitable angle by the 3 screw holes in the two ends of bracket.

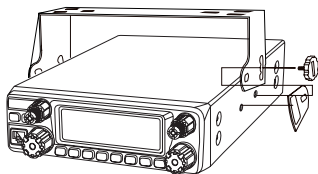
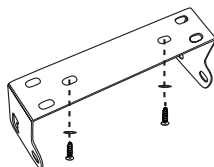

### ✘ Microphone connection

1. Plug microphone connector into jack.
2. Pull on the screw for microphone connector.

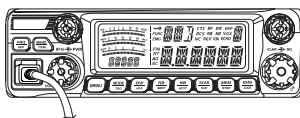
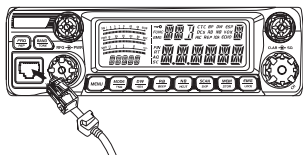



## ❖ ANTENNA INSTALLATION

Before using this radio, please install a high efficient and harmonious adjusted CB antenna, suitable antenna type and correct installation will bring excellent communication.

To match with the radio, the antenna and cable shall with characteristic impedance of 50ohm, or the antenna system will not efficient enough and will disturb TV, radio or other electronics.

1. Screw the antenna connector into the antenna jack.
2. Grounding the antenna system to ensure best performance of this radio.

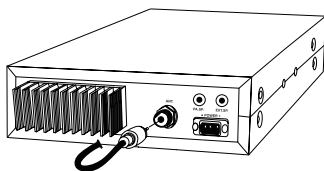

### WARNING:

- ▲ Connect antenna firstly before transmitting, or it might damage the radio.
- ▲ To avoid the risk of fire, electric shock, radio damage, all base station shall equip of lightning protector
- ▲ Be sure choose a matching antenna, you may enquiry our dealers.

3. The position of antenna can be put as following example:

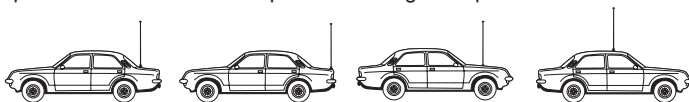

## ❖ POWER CONNECTION

This radio adopt 13.8V power supply, never connect it to 24V battery, And the 13.8V car battery shall with sufficient current, or the LCD will become dark and Transmit power will drop down.

1. Connect positive red power cable with the + terminal of the battery.
2. Connect negative black power cable with the - terminal of the battery.
3. Connect the DC power cable to the transceiver's power supply connector.
  - ▲ We suggest not use cigar lighter as it often bring down the voltage.
  - ▲ Locate the power cable away from high temperature, moisture, portfire and cable insulator.
  - ▲ Use a full power cable even it is longer than need, do not take off the fuse holder from the cable.

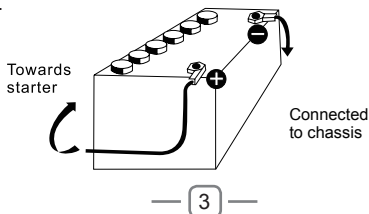

## ❏ Replacing Fuse

This radio adopt 10A, 250V fuse.

If the fuse blows, determine the reason, then correct the problem.

After the problem is resolved, replace the fuse. If newly installed fuses continue to blow, disconnect the power cable and contact your autho-rized dealer or an authorized servicecenter:

1. Pull the two fuse cover in difference direction and open it.

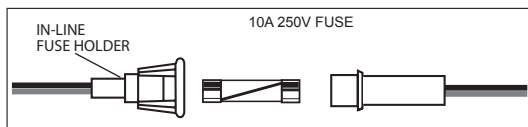

2. Replace the broke fuse with good one, and close the fuse holder.
3. Be sure to use suggested fuse, or it might damage the radio.

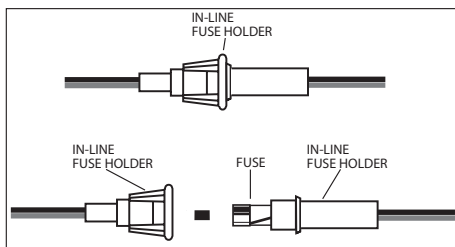

## ❏ Install Microphone Hanger

Choose a ideal location which will not interfere the driver. Using supplied self-tapping screws and pads(2 sets) to fix the hanger.

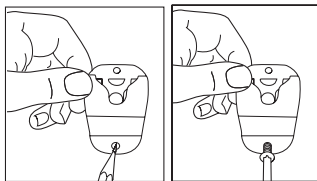

## ❏ Install External Speaker

If use an external speaker, please choose 8ohm speaker with 3.50mm mono band (doulbe cable) plug.

1. Locate the external speaker in a suitable place.
2. Plug into the speaker jack.

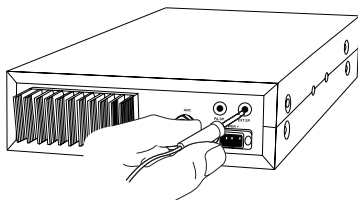

## ■ GETTING ACQUAINTED

### ✘ Front Panel

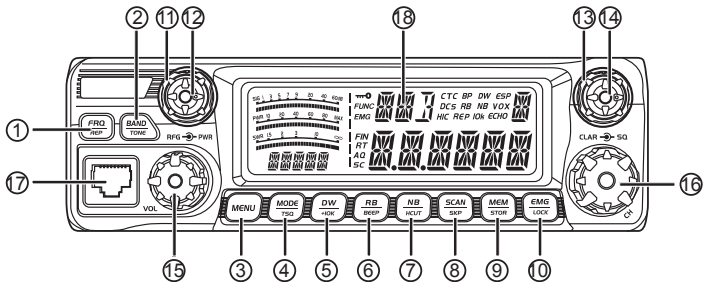

No.	Key	Functions
1	FRQ	Switch between channel mode and frequency mode、offset setup
2	BAND	Switch band: A-1、ECHO setup
3	MENU	Function Menu key
4	MODE	Switch mode(FM、AM、USB、LSB、PA)、TSQ setup
5	DW	Dual-watch scan、Frequency+10K function
6	RB	RB function、Beep voice prompt function
7	NB	NB function、HI-CUT function
8	SCAN	Scan、Scan add、Scan delete
9	MEM	Use、store or delete memory channel
10	EMG	Emergency Channel; Keypad lock.
11	PWR	RF Power Control
12	RFG	RF Gain Control
13	SQ	Squelch Control
14	CLAR	SSB Clarifier switch
15	VOL	Power On/Off; Volume Control.
16	CH	Channel Switch, Push key.
17		Microphone Jack
18		LCD Display

## ❏ Rear Panel

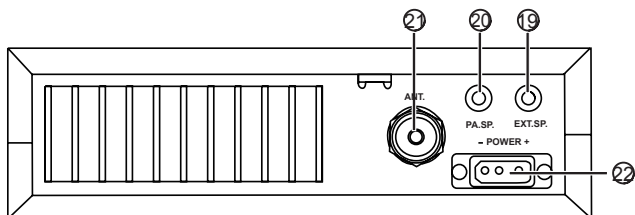

No.	Functions
19	External SP Jack
20	External PA Jack
21	Antenna Jack
22	Power Supply Jack

## ❏ Microphone

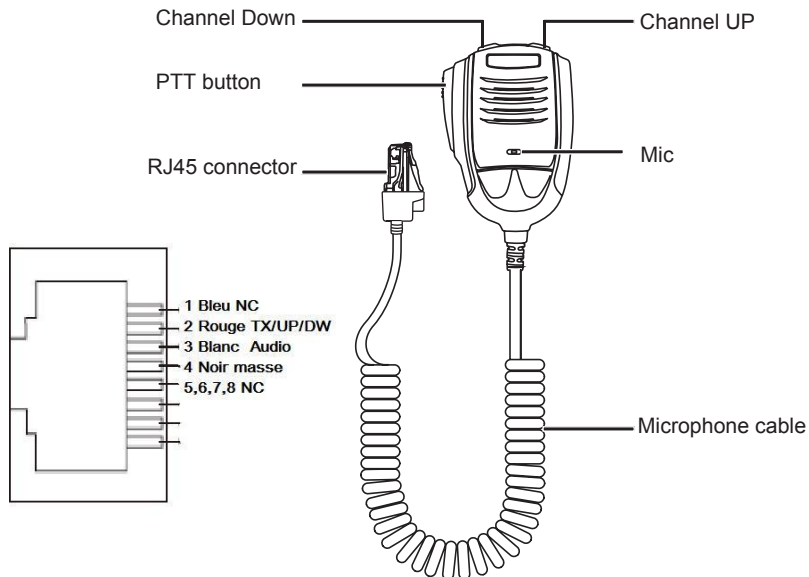

## ✘ LCD Display

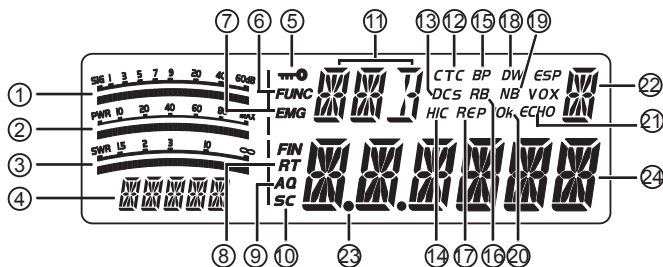

1		RX Signal strength indicator.
2		TX Signal strength indicator.
3		SWR strength indicator.
4		Model name Indicator.
5		Appears when the Keypad lock function is ON.
6	<b>FUNC</b>	Appears when press MENU key.
7	<b>EMG</b>	Appears when using Emergency channel.
8	<b>FIN</b> <b>RT</b>	Appears when adjust SSB clarifier frequency.
9	<b>AQ</b>	Appears when use ASQ.
10	<b>SC</b>	Appears when scan function is ON.
11		Appears when modulation mode is ON.
12	<b>CTC</b>	Appears when set with CTCSS code.
13	<b>DCS</b>	Appears when set with DCS code.
14	<b>HIC</b>	Appears when Hi-cut function is ON.
15	<b>BP</b>	Appears when Beep voice is ON.
16	<b>RB</b>	Appears when RB function is ON.
17	<b>REP</b>	Appears when repeater function is ON.
18	<b>DW</b>	Appears when Dual-watch function is ON.
19	<b>NB</b>	Appears when adjust Noise Blanker is ON.
20	<b>IOk</b>	Appears when add 10k function is ON.
21	<b>ECHO</b>	Appears when Echo function is ON.
22		Working band indicator.
23	•	Appears when scan list is ON.
24		Display of frequency and channel.

## ■ HOW TO USE YOUR RADIO

### ✘ OFF/ON Radio

1. Turn VOL clockwise to switch on the radio, the radio emit a beep. When the LCD displays frequency or channel, the radio is on.
2. Turn VOL anti-clockwise to switch off the radio, the radio is OFF when hear Ka Ta from the switch.

### ✘ Volume Control

When the radio is turned on, turn VOL clockwise will increase the volume, turn VOL anti-clockwise will reduce the volume. The LCD displays **VOL: XX** (XX stands for the volume level, total 1-36 levels).

**Note: Adjust the volume during communication to get suitable level.**

### ✘ RF Power Control

When the radio is transmitting, turn PWR outer shaft to adjust power. Turn it clockwise to increase power, anti-clockwise to reduce power.

### ✘ RF Gain Control

When the radio is receiving, turn RFG inner shaft to adjust RF gain. Turn it clockwise to increase gain, anti-clockwise to reduce gain.

### ✘ SQUELCH Control

When the radio is standby, turn SQ outer shaft clockwise to adjust squelch level. The LCD displays **SQ: XX**. (XX stands for the squelch level, total 1-36 levels).

### ✘ SSB Clarifier control

When the radio is transmitting or receiving, turn CLAR inner shaft to adjust USB/LSB TX or RX frequency. Turn it clockwise to increase frequency, anti-clockwise to reduce frequency.

### ✘ Channel Selection

When radio is in channel mode, turn channel knob to select desired channel. Clockwise to increase, anti-clockwise to reduce channel.

**Note: In channel display mode, each press [ PUSH ] key will increase the frequency by 10 times of channel step size.**

## ✘ Frequency control

1. In frequency mode, press [ **PUSH** ] key, then you can adjust frequency for present channel.
2. When the frequency is flashing, turn CH clockwise to increase frequency, anti-clockwise to reduce frequency.
3. When the frequency is flashing, press [ **PUSH** ] again to adjust frequency step size.

## ■ KEYPAD FUNCTION

### ✘ [ **FRQ/REP** ]

Short press [ **FRQ** ] to switch between frequency display mode and channel display mode.

#### Offset Direction Function

1. Long press [ **FRQ** ] for 2 seconds to enter offset direction function, LCD displays "REP";
2. Press [ **PUSH** ] to select offset, turn channel switch to select;  
**REPOF**: Turn off offset direction function;  
**REP+**: Turn on offset direction function, TX frequency>RX frequency;  
**REP-**: Turn on offset direction function, RX frequency>TX frequency;
3. Press [ **PUSH** ] to store and exit.

### ✘ [ **BAND/TONE** ]

#### Band Selection Function

Short press [ **BAND** ] to choose band A-B-C-D-E-F-G-H-I.

#### Echo Function

1. Long press [ **BAND** ] for 2 seconds to enter ECHO function, LCD displays "ECHO";
2. Long press [ **BAND** ] for 2 seconds to turn off ECHO function.

### ✘ [ **MENU** ]

Long press [ **MENU** ] for 2 seconds to enter menu list.

### ✘ [ **MODE/TSQ** ]

#### Modulation Mode

Short press [ **MODE** ] to choose mode FM-AM-USB-LSB-PA.

## **CTCSS/DCS Function**

1. Long press [ **MODE** ] for 2 seconds to enter CTCSS/DCS function, LCD displays "**CTCSS**" or "**DCS**";
2. Press [ **PUSH** ] to set CTCSS/DCS, turn channel switch to select CTCSS/DCS, then Press [ **PUSH** ] to store and exit.

**OFF:** Turn off CTCSS/DCS function;

**CTCSS:** 67.0~250.3Hz, Total 38 groups;

**DCS:** D023N~D754N, Total 104 groups;

**Note:** This function is available only when install Optional CTCSS board.

## **✘ [ DW/+10K ]**

### **Dual-Watch function**

1. Short press [ **DW** ] to turn on Dual watch, LCD displays "**DW**";
2. Short press [ **DW** ] again or press PTT to exit DW mode;

### **Frequency+10KHz function**

1. Long press [ **DW** ] for 2 seconds to turn on frequency +10KHz function, LCD displays "**10K**";
2. Long press [ **DW** ] for 2 seconds again to turn off frequency +10KHz function.

## **✘ [ RB/BEEP ]**

### **RB function**

1. Short press [ **RB** ] to turn on RB function, LCD displays "**RB**";
2. Press [ **PUSH** ] to select RB frequency, turn on channel switch to select.  
OFF~5, total 6 groups.  
**OFF:** Turn off RB function;
3. Press [ **PUSH** ] to store and exit.

### **BEEP Voice Prompt function**

1. Long press [ **RB** ] for 2 seconds to enter BEEP voice prompt function, LCD displays "**RB**";
2. Long press [ **RB** ] for 2 seconds again to turn off BEEP voice prompt function.

## **✘ [ NB/HCUT ]**

### **NB function**

1. Short press [ **NB** ] to enter NB function, LCD displays "**NB**";
2. Short press [ **NB** ] again to turn off NB function.

### **HI-CUT function**

1. Long press [ **NB** ] for 2 seconds to enter HI-CUT function, LCD displays "**HIC**";
2. Long press [ **NB** ] for 2 seconds again to turn off HI-CUT function



## ✘ [ SCAN/SKP ]

### Scan function

1. Short press [ **SCAN** ] to enter scan function, LCD displays "**SC**";
2. In scan mode, Turn channel switch will change scan direction.
3. Short press [ **SCAN** ] again to exit.

### Add/delete scan list function

1. Long press [ **SCAN** ] for 2 seconds to add or delete the current channel from scan list;
2. When LCD displays "●", current channel is not added to scan list; When LCD does not display "●", current channel is added to scan list.

## ✘ [ MEM/STOR ]

### Using memory channel:

1. Short press [ **MEM** ] to enter memory channel, turn channel switch to choose memory channel. M1-M6, Total 6 memory channels.
2. Short press [ **MEM** ] again to exit memory channel mode.

### Store/Delete memory channel:

#### 1. Store memory channel

When the radio is not in memory channel mode, choose the channel to be stored, and hold [ **MEM** ] enter storage mode, the channel number flashes, Turn Channel switch to choose the location to be stored (M1-M6), then hold [ **MEM** ] until the flashing channel number disappear, the storage is done.

#### 2. Delete memory channel

In channel mode, hold [ **MEM** ] for over 2 seconds, the memory channel number flashes, turn the CH switch to choose the memory to be deleted. Then hold [ **MEM** ] until the flashing channel number disappear, the delete is done.

## ✘ [ EMG/LOCK ]

### Choose EMG channel:

Short press [ **EMG** ] to use Emergency channel, LCD displays "**EMG**".

1. Short press [ **EMG** ] once to choose CH9;
2. Short press [ **EMG** ] again to choose CH19;
3. Short press [ **EMG** ] thrice to return to last normal channel.

### Keypad Lock Function:

1. Long press [ **EMG** ] to lock keys, LCD displays "  ";
2. Long press [ **EMG** ] again to unlock the keys.

**Note:** When this function is turned on, only PTT button is valid.

## ■ BACKGROUND FUNCTION MENU OPERATION

1. Press [ MENU ] for 2 seconds to enter menu list;
2. Turn Channel switch to select menu No.1 to No.10;
3. Press [ PUSH ] to enter the menu setup;
4. Turn channel switch to select wanted setup;
5. Press any other key or wait 5 seconds, the setting will be stored and exit.

No.	Function	LCD Display	Values and Descriptions
1	Mic Gain		1-36, Total 36 levels available; <b>Default:</b> 30.
2	Monitor Gain		1-32, OFF, Total 33 levels available; <b>Default:</b> OFF. (Shut NOG function)
3	TOT		1-600s, OFF, Total 10minutes available; <b>Default:</b> 180S. (Shut TOT function)
4	SWR Protection		<b>OFF:</b> Shut SWR function; <b>ON:</b> Open SWR function; <b>Default:</b> ON.
5	Scan Type		<b>SQ:</b> SQ scan function; <b>TI:</b> Time scan function; <b>Default:</b> SQ.
6	SSB Clarifier switch		<b>OFF:</b> Shut frequency adjustment; <b>R:</b> Open RX frequency adjustment; <b>T:</b> Open TX frequency adjustment; <b>RT:</b> Open TX/RX frequency adjustment; <b>Default:</b> R.
7	Channel Frequency switch		<b>CHAN:</b> Channel adjust; <b>FREQ:</b> Frequency adjust; <b>Default:</b> FREQ.
8	ASQ Control		<b>01~09:</b> Total 9 Levels; <b>Default:</b> 05.
9	Offset frequency		<b>Frequency range:</b> 100Hz~5MHz; <b>Default:</b> 100KHz.
10	Reset		<b>OPT:</b> All function setup resume default; <b>ALL:</b> All channels and setup resume default; <b>Default:</b> OPT.

**CTCSS code**

No.	Freq. (Hz)	No.	Freq. (Hz)	No.	Freq. (Hz)	No.	Freq. (Hz)
1	67.0	11	97.4	21	136.5	31	192.8
2	71.9	12	100.0	22	141.3	32	203.5
3	74.4	13	103.5	23	146.2	33	210.7
4	77.0	14	107.2	24	151.4	34	218.1
5	79.7	15	110.9	25	156.7	35	225.7
6	82.5	16	114.8	26	162.2	36	233.6
7	85.4	17	118.8	27	167.9	37	241.8
8	88.5	18	123.0	28	173.8	38	250.3
9	91.5	19	127.3	29	179.9		
10	94.8	20	131.8	30	186.2		

**DCS code**

Code No.	DSC (Octal)	Code No.	DSC (Octal)	Code No.	DSC (Octal)	Code No.	DSC (Octal)
1	023	27	152	53	311	79	466
2	025	28	155	54	315	80	503
3	026	29	156	55	325	81	506
4	031	30	162	56	331	82	516
5	032	31	165	57	332	83	523
6	036	32	172	58	343	84	526
7	043	33	174	59	346	85	532
8	047	34	205	60	351	86	546
9	051	35	212	61	356	87	565
10	053	36	223	62	364	88	606
11	054	37	225	63	365	89	612
12	065	38	226	64	371	90	624
13	071	39	243	65	411	91	627
14	072	40	244	66	412	92	631
15	073	41	245	67	413	93	632
16	074	42	246	68	423	94	654
17	114	43	251	69	431	95	662
18	115	44	252	70	432	96	664
19	116	45	255	71	445	97	703
20	122	46	261	72	446	98	712
21	125	47	263	73	452	99	723
22	131	48	265	74	454	100	731
23	132	49	266	75	455	101	732
24	134	50	271	76	462	102	734
25	143	51	274	77	464	103	743
26	145	52	306	78	465	104	754

## ■ SPECIFICATIONS

GENERAL	
Frequency Range	28.000-29.700MHz(Programmable)
Frequency Band	A/B/C/D/E/F/G/H/I
Channel	40channels(programmable)in each band
Frequency Control	Phase-Locked-Loop Synthesizer
Frequency Step	100Hz、1KHz、10KHz、100KHz、1MHz
Frequency Tolerance	$\pm 5.00$ ppm
Temperature Range	-20°C to +50°C
Microphone	with push-to-talk /UP/DN and coiled cord
Input Voltage	13.8V
Dimensions (in mm)	250(W) x 280(L) x 60(H)
Weight	1.5kg
Antenna Connector	UHF, SO239

TRANSMITTER	
Power Output	AM: 12W / FM: 30W / SSB: 30W(PEP)
Drain	8A(with modulation)
Modulation	AM/FM/USB/LSB
Inter-modulation Distortion	SSB: 3rd order, more than -25dB; 5th order, more than -35dB
SSB Carrier Suppression	55dB
Unwanted Sideband	50dB
Frequency Response	AM/FM: 300 to 3000Hz SSB: 450 to 2500Hz
Output Impedance	50ohms, unbalanced

## RECEIVER

Sensitivity	SSB: 0.25 $\mu$ V for 10dB(S+N)/N at greater than 1/2-watt of audio output AM: 1.0 $\mu$ V for 10dB(S+N)/N at greater than 1/2watt of audio output FM: 1.0 $\mu$ V for 20 dB (S+N)/N at greater than 1/2 watt of audio output
Adjacent-Channel Selectivity	AM/FM: 60dB    SSB: 70dB
Image Rejection	More than 65dB
IF Frequency	AM/FM: 10.695MHz 1st IF, 455KHz 2nd IF SSB: 10.695MHz
RF Gain Control	45dB adjustable for optimum signal reception
Automatic Gain Control(AGC)	Less than 10dB change in audio output for inputs from 10 to 100,000 microvolt.
Squelch	Adjustable; threshold less than 1.0 $\mu$ V. Automatic Squelch Control(only AM/FM)1.0 $\mu$ V
Audio Output Power	3 watts into 8 ohms
Frequency Response	AM/FM: 300 to 3000Hz    SSB: 450 to 2500Hz
Built-in Speaker	8 ohms, round.
External Speaker(Not Supplied)	8 ohms; disables internal speaker when connected.

# **CONDITIONS OF GUARANTEE**

Our transceivers CRT SUPERSTAR are guaranteed on 2 year. The other equipments : 6 months.

Any abnormality of functioning must be indicated to your retailer, who will intervene or will send it to our technical service for control

The spare parts of our devices are the object of no sending under guarantee

Are excluded of the guarantee:

- the damages caused by accidents, shocks, natural elements (lightning, thunderstorm, static electricity etc.)
- The transistors of power, the microphones, the fuses, the bad uses: badly adjusted antenna (too excessive), inversion of polarity, surge, bad connection etc. recognized by our technical service.
- The interventions having modified the standards of approval of the device.

# **PROCEDURE ON RETURNING TO THE AFTER-SALES SERVICE CRT**

- If you send back a radio under guarantee for repair : you must pay the freight costs to go. CRT will pay the freight costs return. If the radio is not under guarantee postal charges are at your expense.

- each device must be sent accompanied with a photocopy of the invoice as well as with a descriptive note of the noticed defect

If our AFTER-SALES SERVICE estimates the repair more expensive than the value of the device, this one will send you an estimate which must have returned to him accepted or refused. If the estimate is refused, the device will have carriage forward returned.



## DECLARATION OF CONFORMITY

# CE 0700

We hereby declare under our responsibility that the product :

Description : mobile transceiver HF amateur radio

Brand : CRT

Model : SS 7900

Satisfies all the technical regulation applicable to the product within the scope of directive R .TTE 1999/5/CE and european standarts.

EN 60950-1+A1+A11+A12

EN 301 489-1

EN 301 489-15

EN 301 783-1

EN301 783-2

EN 62311

The HAM version was approved in the CEPT countries and those non CEPT countries that implement the CEPT regulation TR 61/01

**CEPT Countries Codes** : ALB-AND-AUT-AZE-BLR-BEL-BIH-BUL-HRV-CYP-CZE-DNK-EST-FIN-F-GEO-D-GRC-HNG-ISL-IRL-I-LVA-LIE-LTU-LUX-MKD-MLT-MDA-MCO-MNE-HOL-NOR-POL-POR-ROU-RUS-SMR-SRB-SVK-SVN-E-S-SUI-TUR-UKR-G-CVA

Notified body PHOENIX TESTLAB GmbH Germany

Mr CELESTRANO PHILIPPE

Manager

Date 30/04/2015



RECYCLABLE

**C.R.T. FRANCE INTERNATIONAL S.A.R.L.**  
Route de Pagny - 21250 SEURRE - FRANCE

Capital de 762 500 euros

Tél. 03 80 26 91 91 - Fax : 03 80 26 91 00

E-mail : [superstar@crtfrance.com](mailto:superstar@crtfrance.com)

Web site : [www.crtfrance.com](http://www.crtfrance.com)